

AMX-Series

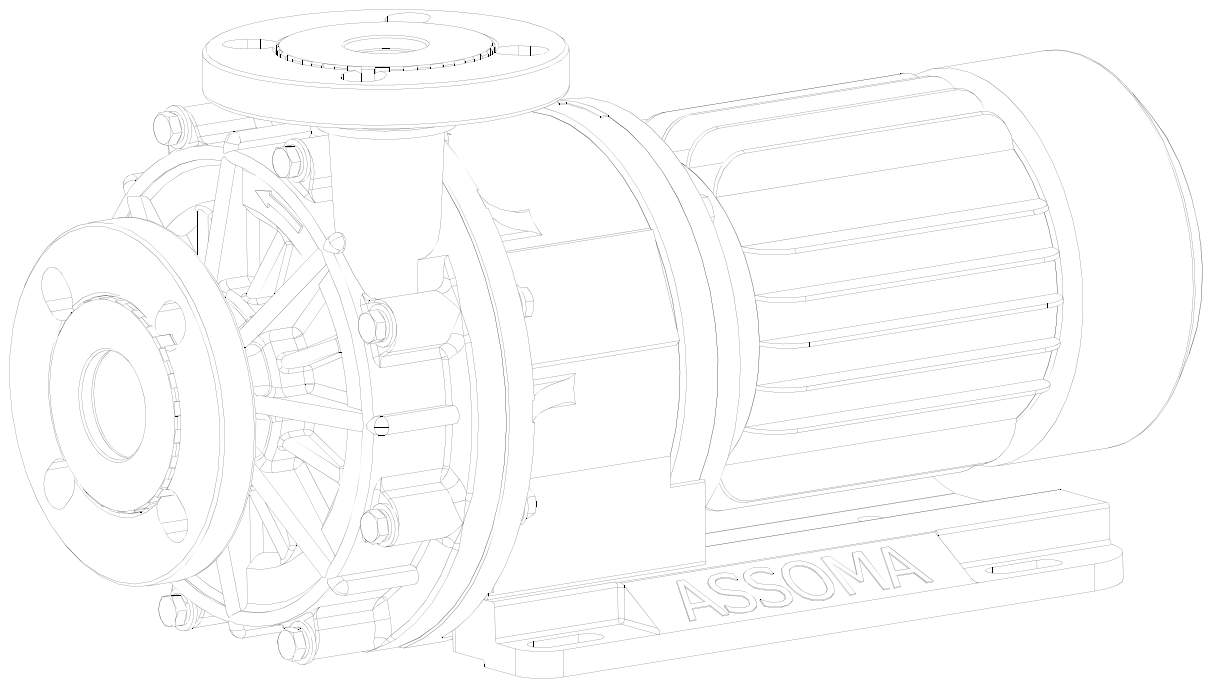

Seal-less Magnetic Drive Pump

User Manual



This manual references the following safety symbols:





	<p>Failure to follow these instruction(s) would most certainly result in serious bodily injury or death.</p>
	<p>Failure to follow these instruction(s) could result in serious bodily injury or death.</p>
	<p>Failure to follow these instruction(s) could result in bodily injury and/or equipment damage.</p>
	<p>Failure to follow these instruction(s) could result in bodily injury or burns.</p>
	<p>Pumps installed in a potentially explosive environment must adhere to these instructions (marked with the Ex symbol). Failure to follow these instructions would almost certainly result in serious bodily injury or death.</p>

Table of Contents





1. FOREWORD.....	1
2. SAFETY REQUIREMENTS	1
3. INSPECTION PRIOR TO INSTALLATION	1
4. INSTALLATION, PIPING, AND WIRING	2
5. OPERATING NOTES	7
6. OPERATING PROCEDURE AND NOTES.....	9
7. MAINTENANCE AND INSPECTION.....	1 0
8. IMPROPER PUMP USAGE	1 3
9. REPAIR AND WARRANTY	1 4
ANNEX A. AMX-SERIES ASSEMBLY AND DISASSEMBLY NOTES ...	1 5
ANNEX B. AMX EXPLODED VIEW AND PARTS LIST	1 6
ANNEX C. DESCRIPTION OF ATEX-SPECIFIC MARKING.....	1 7

1. Foreword

Thank you for purchasing a Crest pump. To ensure proper operation and maximum efficiency, please read this instruction manual carefully. Failure to follow the recommended operating instructions outlined in this manual may result in serious personal injuries and/or equipment damage.

2. Safety Requirements

This section lists general information about safety. The relevant safety requirements for installation, wiring, operation and maintenance are described in the relevant sections. Crest Pumps may not be held liable for personal loss or property damage resulting from failure to follow the safety instructions contained herein.

 DANGER	<p>(1)The explosion proof rating (Annex C) of the AMX-Series pumps are dependent on the material and motor used. Please refer to our specification sheet or consult with a Crest representative, authorized distributor or agent for details.</p> <p>(2)Make sure the power is turned off before connecting, disconnecting or making any changes to the wiring.</p> <p>(3)Do not modify the pump under any circumstances. Doing so may result in unexpected damages or injuries. Crest Pumps., its distributors and agents shall not be held liable for accidents or losses resulting from unauthorized equipment modifications.</p> <p>(4)Appropriate precautionary measures must be implemented when handling hazardous, potentially explosive, or flammable chemicals.</p> <p>(5)Strong magnetic field warning: The AMX-Series pump uses strong permanent magnets (Impeller and Drive Magnet) which may affect certain medical devices (such as pacemakers). Personnel with such devices are advised to consult their physician and device manufacturer to determine a safe distance from the pump.</p>
	
 WARNING	<p>(1)Pump operators must have sound knowledge of the pump and its operations. Unqualified personnel must not be allowed to operate the pump.</p> <p>(2)Do not operate a damaged pump. Doing so may result in property damage or personnel injuries.</p> <p>(3)Do not expose the pump to heat source or open flame. Do not keep flammable objects near the pump.</p>
 CAUTION	<p>(1)To prevent the risk of electric shocks, injury or fire, transportation, installation, piping connections, wiring connections, operation, adjustment, maintenance and inspection must be carried out by qualified personnel only.</p> <p>(2)Do not remove any nameplate or warning labels. Warning labels must be fully visible.</p> <p>(3)Do not stand or place heavy objects on the pump. Doing so may result in injuries or equipment damage.</p> <p>(4)Decommissioned pumps and parts must be disposed of in accordance with local laws and regulations.</p>



3. Inspection Prior to Installation

- (1)Check the pump exterior for any physical damage incurred during transportation.
- (2)Use a small screwdriver or other thin rod to turn the motor's cooling fan. The fan should rotate easily. If the fan is stuck, feels tight or if there are unusual sounds, the pump interior may be damaged. If internal damage is suspected, contact your Crest representative, authorized distributor or agent for assistance with checking and cataloging the damage.

- (3) If the pump was damaged during transportation, contact your Crest representative, authorized distributor or agent immediately to arrange for replacement parts and to allow for timely communication with the logistics company to determine liability.
- (4) Make sure the pump and motor specifications comply with the intended purchase specifications by checking the nameplates. For the pump, check the model, capacity, and head. For the motor, check the power, voltage, frequency, and other specifications required by the order.
- (5) Some motors are designed for use under both 50 Hz and 60 Hz frequencies. However, the pump is customized for either 50 Hz **or** 60 Hz use only. Use under the wrong frequency may result in motor overload or reduced pump performance.
- (6) The pump and motor nameplates contain important baseline information that should be referenced for daily operation and preventive maintenance. Recording and maintaining a copy of the nameplate information is recommended.
- (7) The capacity and head engraved on the pump nameplate is based on the customer's duty point specifications. The "Head" refers to "Total Head", defined as such:

Total Head = Static Head + Dynamic Head

$$\text{Total Head} = H_s + \frac{V_2^2 - V_1^2}{2g}$$

 WARNING	<p>This pump is designed and manufactured according to specifications agreed upon between Crest and the customer. Such specifications include but are not limited to the following: chemical composition, operating temperature, working pressure, environmental factors, and other operating conditions. The operation of the pump must adhere to such specifications. If operating conditions are to be changed, please contact your Crest representative, authorized distributor or agent to obtain written approval prior to changing the operation(s).</p>
 CAUTION	<p>Use proper hoisting or support equipment during unpacking and installation to avoid personal injury and damage to the pump.</p>

4. Installation, Piping, and Wiring

4.1 Installation Location

- (1) The pump should be close to the ground and located near the inlet tank.
- (2) Adequate space should be reserved around the pump to facilitate maintenance and repairs.
- (3) The motor and wiring should be protected from possible flooding.
- (4) The ambient temperature should be kept below 40 °C or above 0 °C.
- (5) The pump should be attached securely to the ground or to a sturdy support structure using anchor bolts.
- (6) The pump should not be used at altitudes above 1000 m.

 WARNING	<p>(1) Use the attached eye bolt (where applicable) to hoist the pump. Lifting from other parts of the pump may damage the pump. <u>Never walk under a raised pump.</u> Serious injuries or death may occur if the pump is accidentally dropped.</p>
---	---

	(2) Before any hoisting activity, make sure the weight rating of the hoisting equipment is appropriate for lifting the pump. Make sure no one is within proximity of the pump while lifting or transporting.
 CAUTION	Please consult with your Crest representative, authorized distributor or agent if the pump is to be installed under any of the following environments: (1) Potentially explosive gas, dust or material is present. (2) Corrosive vapor is present. (3) Ambient temperature is above 40 °C or below 0 °C.

4.2 Piping System

- (1) AMX-Series pumps uses adjustable RF flanges adaptable to mating flange configuration.
- (2) The AMX-Series uses either M16 or 5/8" flange bolts. Recommended tightening torque is 10~12 N · m.
- (3) Refer to Table 4.1 for the allowable loading on the pump.

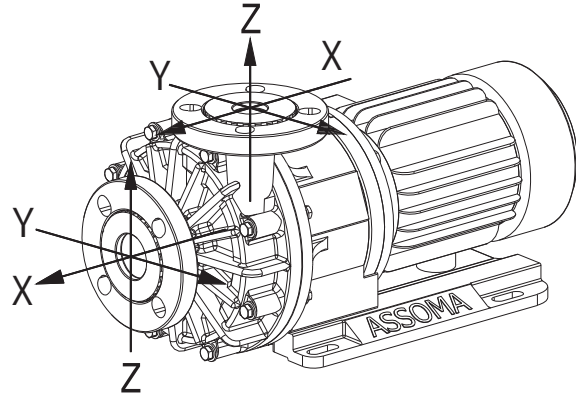

Table 4.1

Model	Suction							
	Force (N)				Moment (N · m)			
	F _x	F _y	F _z	ΣF	M _x	M _y	M _z	ΣM
AMX-220/221/222/223	100	80	80	150	15	25	15	50
AMX-440/441	120	100	100	180	20	30	20	60
AMX-542/543/545 AMX-552/553/555	120	100	100	180	30	50	30	75
AMX-653/655	150	120	120	200	30	50	30	75
AMX-86G/86J	180	145	145	240	35	55	35	80

Model	Discharge							
	Force (N)				Moment (N · m)			
	F _x	F _y	F _z	ΣF	M _x	M _y	M _z	ΣM
AMX-220/221/222/223	80	100	80	150	15	25	15	50
AMX-440/441	100	120	100	180	20	30	20	60
AMX-542/543/545 AMX-552/553/555	120	150	120	200	30	50	30	75
AMX-653/655	120	150	120	200	30	50	30	75
AMX-86G/86J	145	180	145	240	35	55	35	80

Note: The values presented here are applicable for operating temperatures within 40 °C.

4.3 Notes for Installing the Piping System

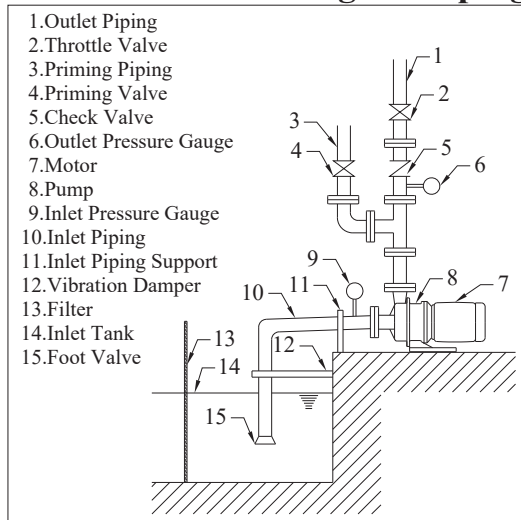

Fig. 4.1

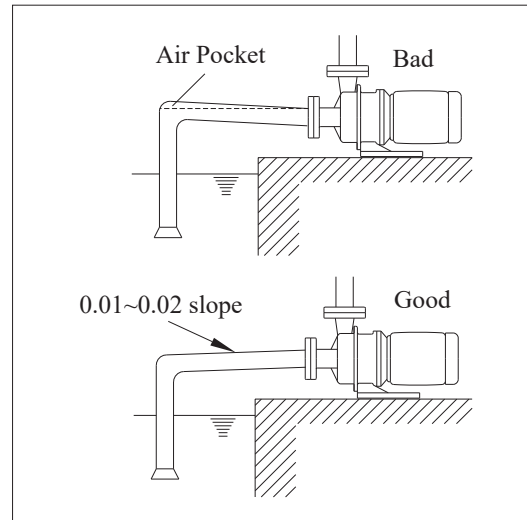

Fig. 4.2

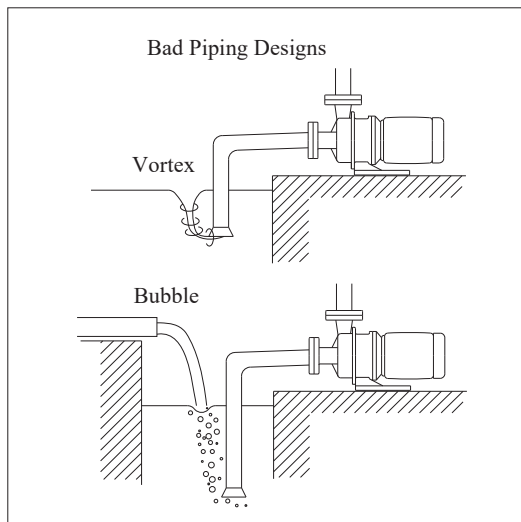

Fig. 4.3

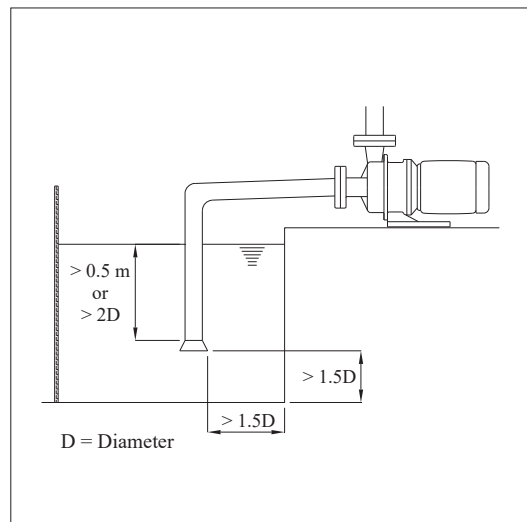



Fig. 4.4

Component	Installation Notes
<p>General requirements</p> <p style="writing-mode: vertical-rl; transform: rotate(180deg);">Suction System</p>	<p>(1) Suction condition must satisfy $NPSHa > NPSHr + 0.5$ m.</p> <p>(2) Minimize suction piping loss by using straight and short piping.</p> <p>(3) The piping should be supported adequately (see Fig. 4.1). The pump should not be used for piping support.</p> <p>(4) Effects of temperature changes should be factored into the support structure design to prevent thermal stress buildup.</p> <p>(5) Suction piping and connectors should be hermetically sealed to prevent drawing in air during operation.</p> <p>(6) The suction piping should not be allowed to collect air. There should be a 0.01~0.02 upward slope towards the pump (see Fig. 4.2). —</p> <p>(7) There should not be any elbows within 5D (5 times diameter) distance from the pump opening. The elbow closest to the pump suction should be a long radial elbow.</p>

Component		Installation Notes
	Suction piping	<p>(1) There should be at least a 1.5D distance between the suction pipe inlet and the closest tank wall to prevent circulation (see Fig. 4.4).</p> <p>(2) The submerge depth of the suction pipe inlet should be at least 0.5m or at least 2D below the liquid surface (see Fig. 4.4).</p> <p>(3) There should be a distance of at least 1.5D between the bottom of the tank and the suction pipe inlet (see Fig. 4.4).</p> <p>(4) If there are two or more inlet piping in the same tank, they should be placed at least 3D apart to prevent mutually disrupting each other's flow.</p>
	Foot valve	Install a foot valve if negative suction or upward suction is used (see Fig. 4.1).
	Self-priming cylinder	<p>(1) For upward suction applications, install a self-priming cylinder to protect the pump from running dry due to a faulty foot valve.</p> <p>(2) The self-priming cylinder should provide a minimum liquid level that is at least 0.5 m above the pump opening.</p>
	Control valve	<p>(1) A control valve should be installed on the suction piping to facilitate maintenance or repairs. This valve should be open at all times and should only be closed when there is a need to remove the pump from the system.</p> <p>(2) A valve with a low piping loss, such as a gate valve, is recommended as the control valve.</p>
	Filter	<p>(1) Filters can introduce an unpredictable increase in piping resistance in the suction system. Therefore, unless absolutely necessary, filters should not be installed on the suction system.</p> <p>(2) If filters have to be used, make sure they are cleaned regularly to maintain an unobstructed flow to the pump.</p>
	Vacuum gauge	<p>(1) The vacuum gauge material should be resistant to the pumped liquid; otherwise, a pressure gauge diaphragm should be used.</p> <p>(2) If the vacuum gauge reading fluctuates during operation, either cavitation has occurred or air bubbles are being sucked into the system.</p>
Discharge System	General requirements	<p>(1) The discharge piping should be properly secured and supported to prevent placing excessive stress on the pump.</p> <p>(2) For systems with a negative suction, priming piping is recommended (see Fig. 4.1).</p> <p>(3) The flow velocity of the liquid should not exceed 3 m/s.</p> <p>(4) For safe operation, discharge piping components must be able to withstand the pressure generated by the pump.</p>
	Priming piping	Upward suction systems without a self-priming cylinder should have priming piping installed.
	Pressure gauge	<p>(1) Pressure gauge selected should be able to measure above the maximum operating pressure of the pump.</p> <p>(2) The pressure gauge material should be resistant to the pumped liquid; otherwise, a diaphragm should be used.</p> <p>(3) A valve can be installed to cut off pressure to the pressure gauge to facilitate pressure gauge maintenance and to prolong the gauge's service life.</p> <p>(4) If the pressure gauge reading fluctuates during operation, either cavitation has occurred or air bubbles are being sucked into the system.</p>

Component	Installation Notes
Check valve	A check valve should be installed under the following condition(s): (1)When the discharge piping is long. (2)Discharge static head exceeds 15 m. (3)Discharge pressure exceeds 1.5 kg/cm ² and flow velocity exceeds 2.5 m/s. (4)Two or more pumps installed in parallel, sharing the same discharge piping. (5)Water hammer may occur when the power is unexpectedly disrupted.
Control valve	(1)A control valve may be installed to control the flow rate. Do not run the pump with the control valve closed for an extended period of time. (2)To minimize motor load during start up, start with a closed control valve and slowly open the valve until the desired capacity or pressure is reached. Always open or close the control valve gradually. (3)If both a check valve and a control valve are to be installed, the recommended installation order should be: Pump → Check valve → Control valve.
Exhaust valve	An exhaust valve or a vent should be installed if the discharge piping travels horizontally for a great distance.

 WARNING	When using the pump to handle dangerous liquids, extra caution should be taken to monitor the pump and its piping system for leaks to prevent personal injury, explosion and/or fire. The following are characteristics of dangerous liquids: (1)Potentially explosive or flammable liquid (2)Corrosive or toxic chemicals (3)Chemicals harmful to humans or detrimental to health (4)Chemicals that could trigger chain reactions
--	--

4.4 Wiring

Wiring must be conducted by qualified personnel, using proper equipment, and in accordance with applicable rules and standards. The following recommendations should be followed:

- (1)Frequency, voltage, and capacity should conform to specifications indicated on the motor nameplate.
- (2)A proper no fuse breaker (NFB) should be selected to suit the rated current of the motor.
- (3)For outdoor use, make sure the breaker and other wiring components are protected from rain and flooding.
- (4)Electromagnetic Contactors (MC) should be kept a safe distance from the pump and should be clearly marked to prevent false starts.
- (5)Motor wiring will vary based on number of wires, voltage, and starting method. Please refer to the wiring diagram provided on the motor terminal box or instruction manual.
- (6)Be sure to comply with applicable local laws and standards when wiring the pump. Make sure to use the proper gauge size, fastening torque, and grounding wire as provided in Table 4.2, Table 4.3, and Table 4.4.

Table 4.2 Wire Size



Model	Recommended Min. Wire Size (mm ²)
3 hp and below	200~480 V 1.6
Above 3 hp	200~240 V 2.0
	380~480 V 1.6

Table 4.3 Terminal Screw and Torque

Screw Size	Recommended Torque (N · m)
M4	1.5
M5	2.5
M6	4.5
M8	8.0
M10	12.0

Table 4.4 Grounding Wire Recommendations

Power Supply Wire Cross Sectional Area S mm ²	Minimum Cross-Section of Grounding Copper Conductors S _P mm ²
S ≤ 16	S
16 < S ≤ 35	16
S > 35	S / 2

 DANGER	(1) Never perform wiring operations with the power still on. (2) Wiring should only be performed by qualified personnel. (3) After wiring, replace the terminal box cover to prevent accidental contacts.
 WARNING	(1) Earth Leakage Circuit Breaker (ELCB) – without an ELCB, operators risk an electric shock if there are current leaks. ELCB installation is recommended prior to operating the pump. (2) The pump should be properly grounded with a recommended ground resistance of 10 Ω or less (In Taiwan, use third type grounding). (3) Each pump should have a separate grounding wire connected directly to the common ground terminal, and must not form closed loop between wires. (4) If long wiring is used, resulting in a 3% drop in voltage, replace with a larger gauge wire.

5. Operating Notes

5.1 Dry-Running

- (1) The seal-less pump uses the transfer media as its cooling system. Without cooling the internal parts becomes over-heated quickly resulting in severe pump damage. Therefore, dry-running must be avoided.
- (2) If dry-running is detected, shut down the pump immediately. DO NOT attempt to cool the pump by opening the valve or priming the pump. The rapid cooling will result in thermal shock which will crack the parts. Allow the pump to cool for at least one hour before priming the pump for operation.
- (3) A dry-run protector is recommended to detect dry-running and stop the pump to prevent pump damage. Contact your Crest representative, authorized distributor or agent for more details.

5.2 Operating Temperature

- (1) Operating temperature may affect the chemicals viscosity, vapor pressure, and corrosiveness. Please state clearly the intended operating temperature to ensure proper pump selection.
- (2) Allowable temperature range (based on clean water):
 Casing material PPG: 0~80 °C
 Casing material ETFE+CF: 0~95 °C
- (3) Allowable operating temperatures for various chemicals may deviate from the above recommendations. Please consult your Crest representative, authorized distributor or agent for details.
- (4) Ideal environmental temperature: 0~40 °C



- (1) When pumping hot chemicals, do not come in contact with the pump casing or piping to prevent burns.
- (2) Any exposed hot surfaces, including the pump, motor, and piping should have warning signs prominently displayed. If possible, hot surfaces should be isolated to prevent accidental contact.

5.3 Concentration, Viscosity, and Specific Gravity

- (1) The concentration of the chemical will affect its viscosity, specific gravity, and corrosiveness. Therefore, chemical concentration must be clearly specified for proper pump selection.
- (2) If the chemical concentration is to change, the specific gravity, and viscosity will change, affecting the shaft power, capacity, and head. Therefore, please check with your Crest representative, authorized distributor or agent to make sure the pump is suitable for the new application.

5.4 Chemicals with Fine Particles

- (1) The magnetic drive seal-less pump is not designed to handle chemicals containing particles. Therefore, depending on the size, concentration and hardness of the particles, the service life of the pump may be reduced.
- (2) For particle concentration less than 5%, particle size smaller than 50 μm, and hardness within 80 Hs, SSiC parts may be used. However, a shorter-than-normal service life can still be expected.



Foreign particles could cause damage to pump parts resulting in failure. Shut down the pump immediately and remove the foreign particle to prevent extensive damage.

5.5 Pump Pressure Limits

The pump's design pressure is based on material characteristics at ambient temperature. At elevated operating temperatures, changes in material strength will change the pressure limitation placed on the pump (see Fig. 5.1). (1 kgf/cm² = 1 bar)

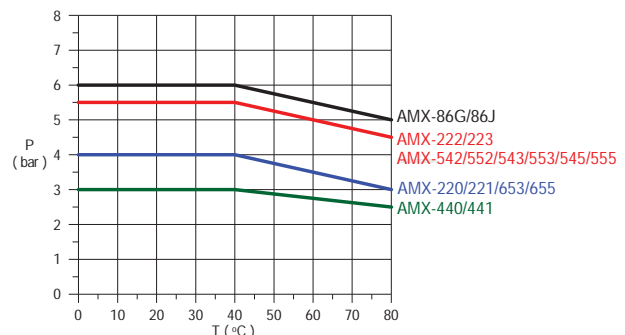

Fig. 5.1

5.6 Minimum Flow

The magnet drive pump uses the transfer media for cooling and lubrication. A low flow rate could result in insufficient lubrication and improper cooling, causing the temperature to rise within the pump. Furthermore, vibration, axial and radial forces will be higher than normal, impacting the service life of the pump. Therefore, minimum flow values are recommended for each of the pump models as shown in Table 5.1.

Table 5.1 Minimum Flow

Unit: l/min

Model	Temperature	20 °C	40 °C	60 °C	80 °C
	AMX-220/221/222/223		10	10	15
AMX-440/441		15	15	20	30
AMX-542/543/552/553		20	20	30	40
AMX-545/555		30	30	40	50
AMX-653/655		50	50	70	100
AMX-86G/86J		80	80	100	120

Note: Values provided in Table 5.1 is based on water. For volatile or viscous fluids, please consult your Crest representative, authorized distributor or agent.

	<p>Do not run the pump with a shut-off discharge valve for more than 1 minute. Heat build-up during extended shut-off operation may damage the pump.</p>
--	--

6. Operating Procedure and Notes

6.1 Before Start-Up

- (1) Check the power supply (frequency, voltage, and wiring).
- (2) Double-check to make sure all screws (flange, casing, base plate, etc.) are securely fastened.
- (3) Perform priming and make sure all air are removed from the pump casing and suction piping.
- (4) Check to make sure all valves on the suction piping are in the open position.
- (5) Use a small screwdriver to rotate the motor cooling fan to make sure it is not too tight or stuck.

6.2 Starting Up the Pump

- (1) Check the direction of rotation of the motor by briefly supplying power to the pump.
- (2) Motor rotation can be checked by looking at the motor fan. Make sure the rotation is clockwise (as seen from the fan), which is also indicated by the arrow on the fan cover. If reverse rotation is detected, make the correction by switching any two phases.
- (3) Close the discharge valve and start up the pump.
- (4) Slowly open the discharge valve until the desired operating capacity or pressure is reached.

6.3 Pump Operation

- (1) Stop the pump immediate if cavitation or dry-run has been detected.
- (2) If de-coupling should happen, shut off the pump to prevent permanently damaging the strength of the magnets.

- (3) During power outages, shut off the pump’s power supply and close the discharge valve.
- (4) When starting the pump with a closed discharge valve, the pressure gauge should register a pressure rise. If the pressure fails to rise or is too low, shut down the pump and check the piping and wiring.

Discharge Pressure = Suction Pressure + Pump pressure

Pump Pressure (kgf/cm²)
 = **Fluid Specific Gravity × Pump Head (m)/10**
 (1 kgf/cm² = 1 bar)

6.4 Shutting Down the Pump

- (1) Slowly close the discharge valve to prevent damage to the pump from water hammer (especially necessary for high capacity applications).
- (2) When shutting down the pump, check to make sure the motor slows down gradually. If the motor stops abruptly, check the pump for potential damages.
- (3) If the pump has been idle for an extended period of time, the pump must be checked before restarting. If the pump is used in a cold operating environment (relative to the fluid’s freezing point), the fluid may crystallize even if the pump is shut down for a very short period of time. To prevent crystallization, a drain should be included in the piping system to drain the pump during shutdown. Alternatively, a heating system could be used to maintain the fluid temperature during shutdown.

7. Maintenance and Inspection

7.1 Daily Inspection

Table 7.1

Appearance	(1) Check the pump exterior (casing, bracket, and base) for signs of oxidation or corrosion. (2) Check the pump and piping system for leaks. (3) Check the motor exterior for rusting, corrosion, and peeled paint.
Operation	(1) Check the pump for irregular noise and vibration. (2) Check the motor for signs of overheating, phase imbalance, and bearing noise. Make sure air circulation of the cooling fan is not obstructed. (3) Check the suction tank liquid level and the suction and discharge pressures. (4) Make sure the operating current and motor loading is within limits. (5) Check stand-by pumps regularly to make sure they are functional when needed.

7.2 Scheduled Maintenance

- (1) The items in Table 7.2 should be checked on a quarterly basis.
- (2) Please refer to Annex A for assembly and disassembly notes, and see Annex B for a list of the pump parts.

Table 7.2 Inspection Items

Part	Inspection	Remedy
Pump Casings	(1)Cracks (2)Scratch marks (except when pumping particle laden fluids) (3)Crystallization or sludge (4)Shaft support damaged or deformed	(1)Replace (2)Seek advise** (3)Clean (4)Seek advise**
Gasket/O-Ring	(1)Deformed (2)Corroded or swollen	(1)Replace (2)Seek advise**
Impeller Ass'y	(1)Cracks or scratch marks (2)Damaged bearing or crystallization (3)Worn bearings (4)Crystallization or sludge on the impeller surface (5)Foreign object clogging the impeller (6)Deformed impeller	(1)Seek advise** (2)Seek advise** (3)Refer to Table 7.3. Replace if worn excessively- (4)Clean (5)Clean (6)Seek advise**
Shaft & Thrust Rings	(1)Scratch marks (2)Cracks	(1)Seek advise** (2)Replace
Motor	(1)Phase resistance and insulation impedance (2)Check bearing lubricant if using open bearings	(1)Repair if abnormal (2)Maintain proper lubrication

**Contact your Crest representative, authorized distributor or agent.

 CAUTION	<p>The Gasket or O-Rings should be replaced even if they don't display any signs of corrosion or deformation. Prolonged use may reduce the elasticity of the Gasket or O-Rings, resulting in future failure.</p>
---	--

7.3 Replacement Limits and Recommendations for Wear Parts

Table 7.3 Replacement Limits for Wear Parts

Unit: mm

Model	Dimension		New Part	Usage Limit
	Part			
AMX-220/221 AMX-440/441	Shaft (Outer Diameter)		15	14.5
	Bearing (Inner Diameter)		15	15.5
	Thrust Ring (Thickness)		6	5
	Wear Ring (Thickness)		6	5
AMX-222/223	Shaft (Outer Diameter)		18	17.5
	Bearing (Inner Diameter)		18	18.5
	Thrust Ring (Thickness)		6	5
	Wear Ring (Thickness)		6	5
AMX-542/543/545 AMX-552/553/555 AMX-653/655	Shaft (Outer Diameter)		18	17.5
	Bearing (Inner Diameter)		18	18.5
	Thrust Ring (Thickness)		7	6
	Wear Ring (Thickness)		7	6
AMX-86G/86J	Shaft (Outer Diameter)		28	27.5
	Bearing (Inner Diameter)		28	28.5

Model	Dimension		New Part	Usage Limit
	Part			
	Thrust Ring (Thickness)		11	10
	Wear Ring (Thickness)		10	9

Note: Table 7.3 provides the recommended replacement dimensions for the individual parts. It should be noted that relative dimensions should also be considered. The total wear between the shaft and the bearing should not exceed 0.5 mm. Total wear between thrust ring and wear ring should not exceed 1 mm. The part with more wear should be replaced.

7.4 Preventive Maintenance

Operating data, like vibration, current, power, and flow rate, should be tracked through setting upper and lower control limits for each variable. This trend analysis data (see Fig. 7.1) should form the basis for determining when preventive maintenance should be carried out.

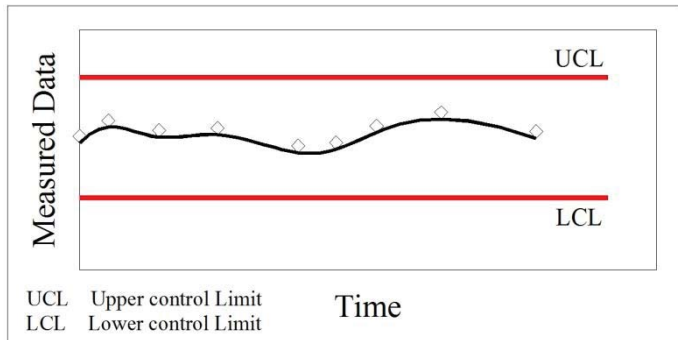





Fig. 7.1 Trend Analysis for Preventive Maintenance

	<p>(1) Strong magnetic field warning: The AMX-Series pump uses strong permanent magnets (Impeller and Drive Magnet) which may affect certain medical devices (such as pacemakers). Personnel with such devices are advised to consult their physician and device manufacturer to determine a safe distance from the pump.</p> <p>(2) Turn off the power prior to performing any maintenance work or inspection. Take precautionary measures to make sure others do not accidentally re-establish power to the equipment. If the work environment is noisy or has poor visibility, place a sign on the power supply notifying other that work is “In Progress” to prevent accidental operations that may lead to injuries.</p>
	<p>(1) Only handle toxic or volatile chemicals in a well ventilated environment. Make sure all personnel exposed to the environment wear proper protective gear (such as protective vests, face shield, safety goggles, and protective gloves, etc.)</p> <p>(2) Modification: Modifying the pump could result in equipment damage, electric shock or personal injuries. Do not attempt to modify the pump. Contact your Crest representative, authorized distributor or agent for advice if the pump no longer meets your operational needs.</p> <p>(3) Strong Magnet Warning: This pump contains strong magnets (impeller and drive magnet). Be careful when handling the magnets to prevent injuries to the hand or fingers. Keep magnetic cards and other sensitive electronic equipment away from the pump to prevent damage.</p>
	<p>(1) Use the right tools for the assembly or disassembly of the pump.</p> <p>(2) Hazardous Chemical Warning: If the pump is being used for handling hazardous chemicals, be cautious when disassembling the pump. Make sure to rinse the pump and parts thoroughly and be aware of remnant chemicals that may be present on the parts after cleaning.</p>

8. Improper Pump Usage

	Abnormal Use Condition	Potential Damage or Symptom
System Calculation Error and Wrong Pump Selection	System resistance too high or Pump head too low	(1)Insufficient capacity or no flow (2)Insufficient pump cooling (3)Excessive axial and radial force, reduced bearing and thrust ring service life
	System resistance too low or Pump head too high	(1)Flow rate too high (2)Overloading of the motor (3)Insufficient NPSHa, resulting in cavitation
	Insufficient NPSHa, resulting in Cavitation	(1)High frequency vibration and noise (2)Fracturing of the bearing or thrust rings (3)Reduced performance, resulting in low flow rate (4)Severe cases may result in dry-running
	Specific Gravity (S.G.) too high	(1)Overloading of the motor (2)Decoupling of the magnet coupling
	Viscosity too high	(1)Overloading of the motor (2)Decoupling of the magnet coupling (3)Reduced performance, resulting in low flow rate
	Improper material selected	(1)Corrosion or cracking of the casing or impeller (2)Rapid corrosion and wear of the bearing (3)Corroded O-ring seal, resulting in leakage
Improper Piping or Layout	Insufficient liquid level or leaking suction	(1)High frequency vibration and noise (2)Fracturing of the bearing or thrust rings (3)Reduced performance, resulting in low flow rate (4)Severe cases may result in dry-running
	Air pockets in suction piping	(1)Reduced performance, resulting in low flow rate (2)Severe cases may result in dry-running
	Improper parallel pump design	Pump with worse suction condition or both pumps: (1)Reduced performance, resulting in low flow rate (2)Severe cases may result in dry-running
	Leaking foot valve or leaking suction	Loss of liquid within pump during shut-down, resulting in dry-running when pump is restarted
Improper Operation	Improper Priming	Pump damage from dry-running
	Insufficient speed or reversed rotation	Insufficient capacity
	Incorrect frequency or voltage	Overloading of the motor
	Insufficient suction tank liquid level	(1)Reduced performance and high vibration (2)Fracturing of the bearing or thrust rings (3)Pump damage from dry-running
	Foreign object lodged in impeller	(1)Vibration and noise (2)Reduced performance, resulting in low flow rate (3)Severe cases may result in dry-running
	Extended period of low flow	(1)Insufficient pump cooling (2)Excessive axial and radial force, reduced bearing and thrust ring service life

Abnormal Use Condition		Potential Damage or Symptom
	Closed suction valve	Pump damage from dry-running
	High liquid temperature	(1)Insufficient NPSHa, resulting in cavitation (2)Weakened magnetic strength, resulting in decoupling
	Particles in liquid	(1)Excessive wear to the bearings (2)Abrasive wear to the casing and impeller
Improper Maintenance	Deformed Gasket/O-ring seal	Leakage
	Damaged impeller	(1)Vibration and noise (2)Reduced performance, resulting in low flow rate
	Motor bearing failure	(1)Vibration and noise (2)Overloading of the motor (3)High motor temperature
	Worn wear-ring	(1)Vibration and noise (2)Overloading of the motor
	Worn bearing	(1)Vibration and noise (2)Severe cases may result in breaking of the shaft
	Loose base screws	Vibration and noise
	Clogged suction (inlet pipe, foot valve, or filter)	(1)Reduced performance, resulting in low flow rate (2)Insufficient NPSHa, resulting in cavitation (3)Severe cases may result in dry-running
	Blocked discharge	(1)Insufficient capacity or no flow (2)Insufficient pump cooling (3)Severe cases may see thermal damage to the pump and discharge piping

9. Repair and Warranty

When a problem arises, please use this manual for initial troubleshooting. If the issue cannot be found or if pump or motor is suspected to be damaged, contact your Crest representative, authorized distributor or agent for further instructions. Have the following information ready when you make the call:

- (1)Pump model and serial number indicated on the pump name plate
- (2)Pump’s designed operating condition
- (3)Operating condition prior to failure

Standard warranty period for the pump is 12 months from the pump delivery date as stated on the warranty card. Replacement of parts designed for wear, such as bearings and Gasket/O-Rings are not covered under the warranty. Warranty covers failure due to manufacturing or part defects under normal operation and under the intended operating condition as stated on the pump specification sheet.

Annex A. AMX-Series Assembly and Disassembly Notes

A.1 Prior to Disassembly

- (1) Prior to disassembly, be sure to wear corrosive-resistant protective gear (clothing, gloves, goggles, etc.) suitable for the corrosive or toxic media to prevent injuries from accidental spillage.
- (2) The AMX-Series pump uses strong magnets (impeller and drive magnet). Be careful when assembling and disassembling to prevent injuries to the hand or fingers. Keep magnetic cards and other sensitive electronic equipment away from the pump to prevent damage and data loss.
- (3) Mark the wires before disconnecting to ensure the phases are connected correctly when reconnecting.

A.2 Prior to Assembly

- (1) When reassembling the pump, simply reverse the steps used for disassembling.
- (2) When inserting the bearings into the impeller assembly, take care to make sure the edges align with corresponding edges within the impeller.
- (3) Wipe the parts down thoroughly and take special care to make sure no metal filings adhere to the magnet capsule or the drive magnet.
- (4) When tightening the screw sets, make sure to tighten opposite pairs to ensure even compression.
- (5) After assembly, use a small screw driver to turn the motor fan to make sure the parts can rotate easily and smoothly.
- (6) Tightening torque recommendations for AMX-Series Front casing:
 - Material PPG : $12 \pm 0.5 \text{ N} \cdot \text{m}$ ($120 \pm 5 \text{ kgf} \cdot \text{cm}$)
 - $15 \pm 0.5 \text{ N} \cdot \text{m}$ ($150 \pm 5 \text{ kgf} \cdot \text{cm}$) for AMX-86G/86J only
 - Material ETFE+CF : $10 \pm 0.5 \text{ N} \cdot \text{m}$ ($100 \pm 5 \text{ kgf} \cdot \text{cm}$)

Annex B. AMX Exploded View and Parts List

Part No.	Part Name	Part No.	Part Name
101	Pump Casing Assembly	403/412+NO.	Gasket/O-Ring
220	Front Support, Shaft	161.01	Rear Casing
211	Shaft		Rear Thrust Ring
319	Front Buffer(expect AMX-86G/86J)	161.02	Backup Plate (except AMX-440)
	Front Thrust Ring	181	Bracket
230	Front Wear Ring		Rear Bracket
	Impeller	890	Base Plate
847.01	Magnet Capsule	891	Motor Support (for 5/7.5/10 hp pumps only)
310	Bearing	847.02	Drive Magnet
		800	Motor

Note: The flange thickness for the motor can vary greatly between different brands and materials. When replacing with a different motor, please consult your Crest representative, authorized distributor or agent for suitable bolt specification.

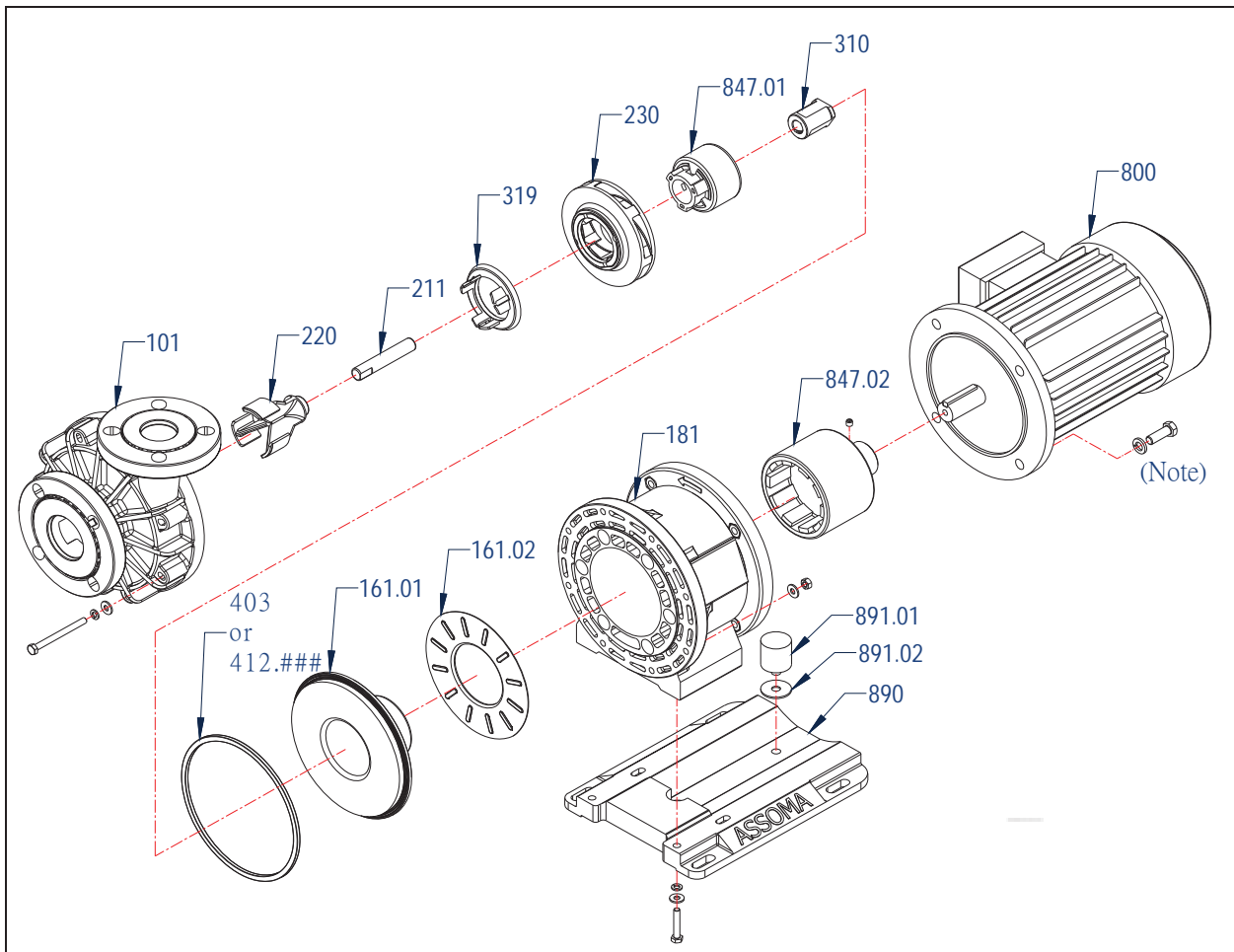



Annex C. Description of ATEX-Specific Marking

- (1) The ATEX-specific marking of this pump (without motor) is described below.
 (2) Please refer to the motor name plate for the motor's ATEX marking.

Pump ATEX Mark:

 II 2 G c IIA T4

	Distinctive Community mark
II	Equipment group: All except for underground mines
2	Equipment category: For equipment providing a high level of protection when used in areas where an explosive atmosphere is likely to occur (suitable for use in Zone 1)
G	Explosive atmosphere: Flammable gases
c	Protection type: Constructional safety
IIA	Gas subdivision: Surface above ground industries with less easily ignited gases, e.g. propane
T4	Temperature class: Maximum permissible surface temperature of 135 °C

 	<p>(1) When using the pump in a potentially explosive environment, a suitable explosion-proof motor must also be selected to ensure the entire pump is suitable for use in the environment.</p> <p>(2) Both the pump and motor must be properly grounded to limit the risk of static electricity discharge. A metallic bracket must be used for category 2 application. The pump can only be used in a category 3 environment if a plastic bracket is used.</p> <p>(3) Dry-running is absolutely forbidden. Do not run the pump at below minimum flow for more than one (1) minute to prevent temperature build-up within the pump. Installation of a certified dry-run protection device that conforms to local standards is highly recommended to shut down the pump and prevent sustained dry-running.</p> <p>(4) Temperature sensors are recommended to monitor pump and motor surface temperatures.</p>
--	--